



User's Operation Manual

Though every effort has been made to ensure accuracy, this manual may include technical or typographical errors. Contents of this manual may be changed from time to time due to product improvement. These changes will be incorporated in new editions of this manual. We disclaim liability for any changes errors or omission.

FCC Notice

Warning. This equipment generates and uses radio frequency energy and if not installed and used properly, that is, in strict accordance with manufacturer's instructions, may cause interferences with radio and television reception. It has been type tested and found to comply with the limits for a Class B computing device in accordance with the specifications in Subpart J of Part 15 of FCC Rules, which are designed to provide reasonable protection against such interference in a residential installation. However, there is no guarantee that interference will not occur in a particular installation. If this equipment does cause interference to radio or television reception, which can be determined by turning the equipment off and on, the user is encouraged to try to correct the interference by one or more of the following measures

- Reorient the receiving antenna.
- Relocate the computer with respect to the receiver.
- Move the computer away from the receiver.
- Plug the computer into a different outlet so that the two devices are on different branch circuits.
- If necessary, the user should consult the dealer or an experienced radio/television technician for additional suggestions. The user may find the following booklet prepared by the Federal Communications Commission helpful "How to identify and Resolve Radio TV interference problems" This booklet is available from the U.S. Government Printing Office, Washington, DC20402, Stock No. 004-000-00345-4.

Please note In order for an installation of this product to maintain compliance with the limits for a Class B device, shielded cables must be used for the connection of any devices external to this product.

TM IBM PC/XT/AT are registered trademarks of International Business Machines Corporation. Microsoft is a registered trademark of Microsoft Corporation. Hercules Graphics is a registered trademark of Hercules Computer Technology.

CONTENTS

PAGES

1.	Introduction	1-1
1.1	For the mini G7 you should have	1-1
1.2	Optional Accessories for mini G7	1-2
1.3	Features	1-3
1.4	The mini G7 requires	1-3
1.5	Connectors and Switches Description	1-3
2.	Installation	2-1
2.1	Selection of Video Display	2-1
2.2	To configure the System for Video Display	2-4
2.3	Connection of Composite Video Display Connector	2-6
2.4	Mouse Interface	2-7
2.5	Parallel Printer Interface	2-9

Appendix A Mouse Interface

A-1

Appendix B Specifications

B-1

1 Introduction

Welcome to your mini G7 system, the Leading Edge Multi-Display I/O Adapter Series.

The mini G7 and its accessories are designed to replace color graphics adapter, monochrome display adapter, Hercules monochrome graphics adapter, parallel printer adapter and mouse adapter

1.1 For the mini G7 you should have

*A mini G7 Multi-display and I/O Adapter

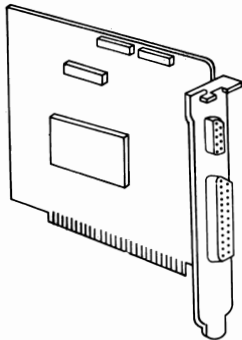

*A mini G7 User's Operation Manual

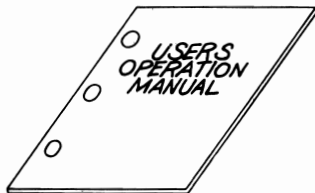

1-1

1.2 Optional Accessories for mini G7

G7-P9 Composite Video display and Mouse Cables with Connectors and Bracket

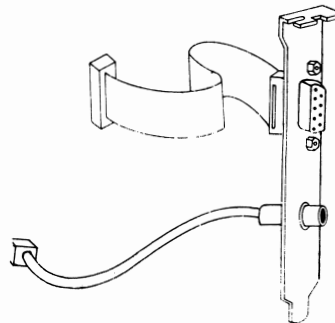

G7-P2 G7-Mouse

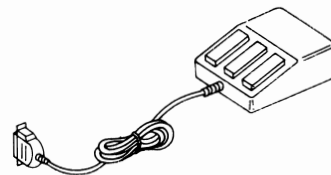

1-2

1.3 Features of the mini G7

- (1) IBM Color Graphics Adapter compatible.
(Support 640x200 four colour graphics mode)
- (2) IBM Monochrome Display Adapter compatible.
- (3) Hercules Monochrome Graphics Adapter compatible.
- (4) Microsoft Mouse Adapter compatible.
- (5) IBM Printer Adapter compatible.
- (6) Support NTSC system televisions and color monitors.
- (7) Support Composite Monochrome monitors.

1.4 The mini G7 requires:

- * An IBM PC/XT/AT or compatible computer system.
- * A monitor.

1.5 Connectors and Switches of mini G7

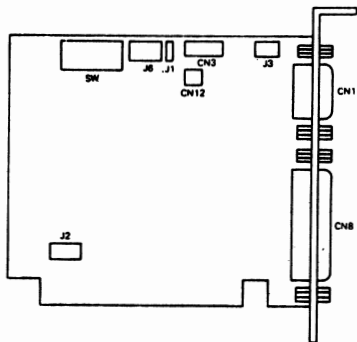

- CN1 DB9 connector for direct drive monitor
CN3 Mouse connector
CN8 Printer connector
CN12 Video jack for composite display

- J1 Composite color/mono select switch
J2 Mouse interrupt level select switch 1
J3 Oscillator frequency select switch
J6 Mouse interrupt level select switch 2
SW Video mode select Switch and Printer/Mouse enable Switch

2. Installation

2.1 Selection of Video Display

Set the jumper and switch on the mini G7 for video display accordingly

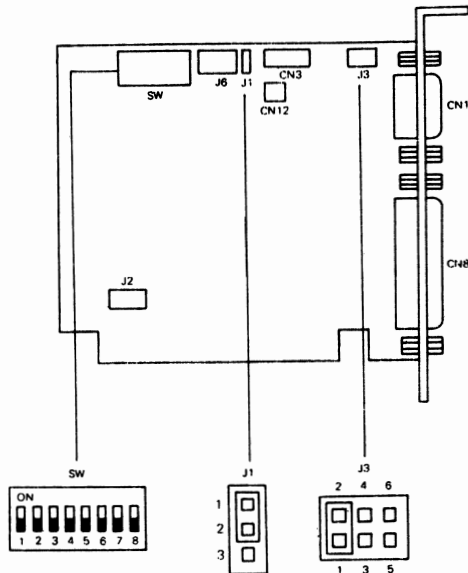

J1 Setting

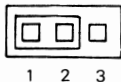

Jumper	Display Mode Selected	Output
1 - 2*	Composite Color Display	CN2
2 - 3	Composite Mono Display	CN2

* Default Setting

J3 Setting

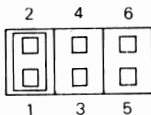

Jumper	Clock Frequency
1 - 2*	Composite/RGB Monitor
3 - 4	TTL Monochrome Monitor
5 - 6	Not Used

* Default Setting

SW Setting



SW1	
On	Positive Vertical Synchronize Pulse
Off	Negative Vertical Synchronize Pulse

SW2	
On	Positive Horizontal Synchronize Pulse
Off	Negative Horizontal Synchronize Pulse

SW1	SW2	SW3	SW4	SW5	Display Mode Selected	Output
On	On	Off	Off	On	Composite Color Graphics Display	CN12
On	On	Off	On	Off	Composite Monochrome Graphics Display	CN12
On	On	On	Off	On	* RGB Color Graphics Monitor	CN1
Off	On	On	On	On	TTL Monochrome Graphics Monitor	CN1

SW8	Not Used
-----	----------

* Default setting

2.2 To configure the system for Video Display

Set the switch on the system for the video display option accordingly

WARNING:

Turn off the power of the system before you alter any switch setting.

- (i) For the IBM PC/XT, you have to set the switch SW1 position 5 and position 6 according to the following table –

XT System Board

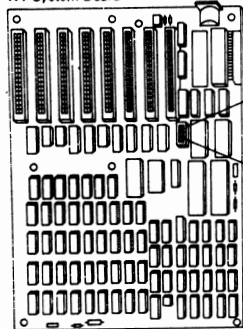

Front



Display Mode	Position 5	Position 6
Composite Monochrome Display	On	Off
*Composite Color Display	Off	On
Color Graphics Display	On	Off
Monochrome Graphics Display	Off	Off

* 40x25 text mode

- (ii) For the IBM PC/AT, set the display switch as indicated below and run the SET UP PROGRAM in the IBM AT diagnostics diskette.

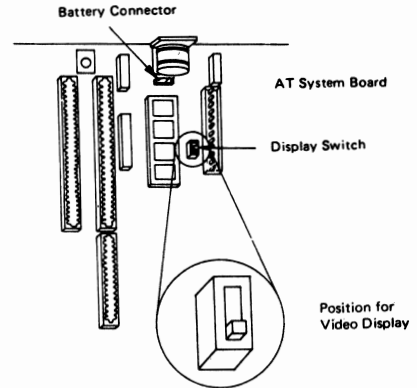

Display Mode	Display Switch
Composite Monochrome	
Composite Color	
Color Graphics	
Monochrome Graphics	

2.3 Connection of Composite Video Display Connector

- (i) In order to have the composite video display, you should have optional accessory G7-P9 connect the connector of 2-ways Cable (the lower one) on the bracket to the Video Connector, CN12, on the mini G7 adapter. G7-P9 is available from your local dealer.

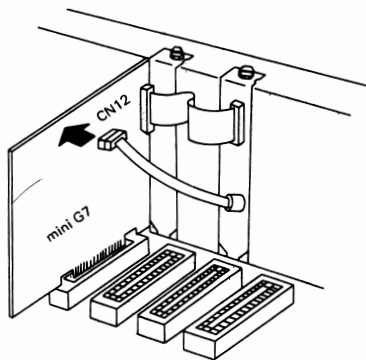

- (ii) Connect the Composite Color/Mono display monitor to the video jack (the lower one) on the bracket.

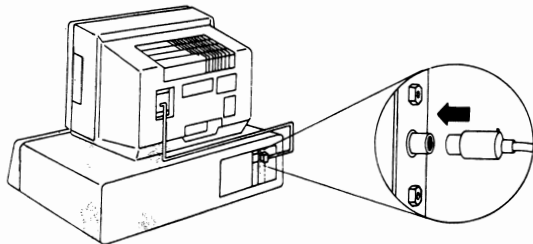

2.4 Mouse Interface

Your mini G7 has a built-in Microsoft Mouse compatible interface. You need to have an optional accessory G7-P2 (G7-Mouse) to work with. G7-P2 is available from your local dealer.

- (i) For using the mouse, **make sure that jumper J2 and jumper J6 are set at the same interrupt level.** Normally, there is no need to change the interrupt level of the mouse unless the selected interrupt level is already used by other devices.

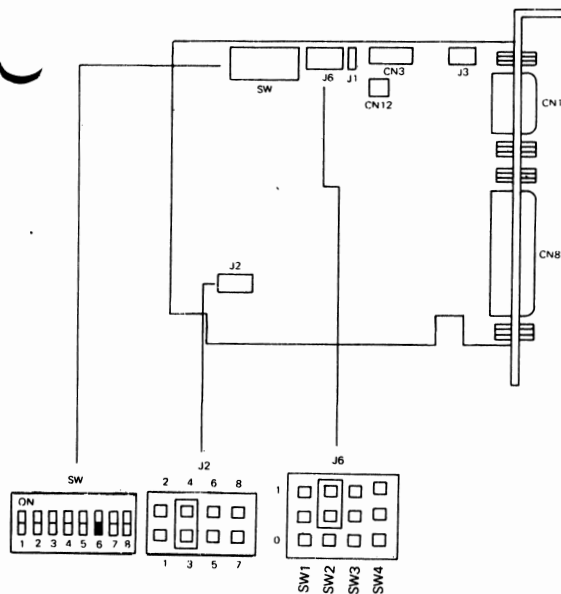

WARNING: In IBM PC/AT, set the jumpers J2 to other interrupt position. Abnormal operation may be caused if interrupt 2 is selected.

Setting the interrupt Jumper

Interrupts are temporary breaks in the sequence of a program caused by various input/output devices such as printers, plotters, disk drivers and keyboard. No two devices connected to the same computer can use the same interrupt level. You must specify a mouse interrupt that does not interfere with the other devices connected to your computer.

Use the following list and table to determine how you should set the mouse interrupt level.

If you have	Do not use interrupt
IBM PC AT	2
IBM PC with a fixed disk	5
IBM PC/XT	5
Asynchronous Communications Adapter 1st serial port (COM1)	4
Binary Synchronous Communications Adapter 1st serial port (COM1)	4 or 3
Synchronous Data Link Control Commu- nications Adapter	4 or 3
Asynchronous Communications Adapter 2nd serial port (COM2:)	3
IBM Enhanced Graphics Adapter	2
IBM Network Adapter	2

The Setting of SW, J2 and J6 are as follows:

SW Setting

On	On	SW6		Output
Off	1 2 3 4 5 6 7 8	On	Enable Mouse	CN3
		Off*	Disable Mouse	CN3

J6 setting:

Jumper		Position
J6	SW1	0 1 Select mouse to use interrupt 2. (usually used by mouse)
	SW2	0 1* Select mouse to use interrupt 3. (usually used by RS23211)
	SW3	0 1 Select mouse to use interrupt 4. (usually used by RS232 I)
	SW4	0 1 Select mouse to use interrupt 5. (usually used by HD)

J2 setting:

Jumper	Position
J2	1 - 2 Select mouse to use interrupt 2
	3 - 4* Select mouse to use interrupt 3
	5 - 6 Select mouse to use interrupt 4
	7 - 8 Select mouse to use interrupt 5

* Default setting

2.5 Parallel Printer Interface

- (i) The followings are switch settings for the parallel printer interface

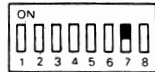
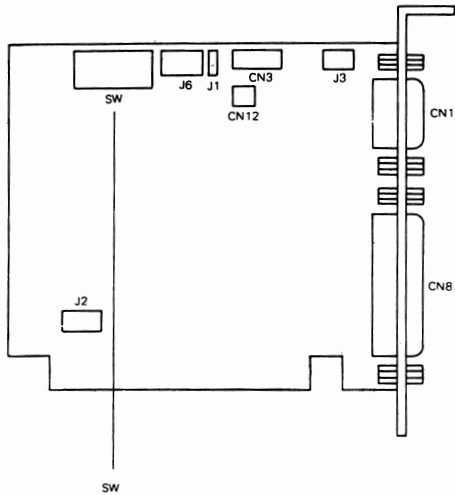

SW

SW7		Output
On*	Enable Printer	CN8
Off	Disable Printer	CN8

* Default setting

Appendix A Mouse Interface Connector (CN3)

6	7	8	9	10
1	2	3	4	5

Pin No	Signal	Direction
1	Y Pulse B	Input
2	Y Pulse A	Input
3	X Pulse B	Input
4	X Pulse A	Input
5	+5V	
6	Ground	
7	Right Button	Input
8	Middle Button	Input
9	Left Button	Input
10	Not Used	

Appendix B Specifications

Operating Voltage	:	5V + 5%
Current	:	5V / 250mA (Typical)
Size	:	112mm x 90.5mm x 1.6mm
Temperature	:	
Operating		5°C–40°C
Storage		0°C–55°C
Relative Humidity	:	
Operating		20% – 80% (Non condensed)
Storage		5% – 80% (Non condensed)

Note: Due to engineering improvements, specifications are subject to change without further notice.